

amop®  
synergies



HOUSE & GARDEN

COVERINGS

YARDS AND POOLS

OUTDOOR FURNITURE

CASA & JARDIM

REVESTIMENTOS

PÁTIOS E PISCINAS

MOBILIÁRIO DE EXTERIOR



## PAVINGS

PÁG 4-10

### CARACTERÍSTICAS FEATURES

#### Mosaico Hidráulico

Pavimentos em lajetas de betão tradicionais, com vasta gama de cores e texturas, produtos económicos.  
Absorção de água aprox. 6%.  
Elevada resistência.

#### Hydraulic Mosaic

Floor coverings in concrete traditional slabs, with variety of colors and textures, economic products. Water absorption  $\approx$  6%.  
High Resistance.

### APLICAÇÕES APPLICATIONS

Pavimento Exterior  
Lajetas Sobre Apoios  
Base Flexível Uso Pedonal  
Base Rígida Uso Rodoviário

Outdoor Paving  
Slabs over supports  
Flexible Base for pedestrian use  
Rigid Base for car traffic use

## MONO K

PÁG 11-26

### CARACTERÍSTICAS FEATURES

#### Pedra Reconstituída

Revestimentos em pedra natural reconstituída. Soluções técnicas económicas.  
Baixa absorção de água aprox. 3%.  
Elevada resistência, baixa espessura.

#### Reconstituted Stone

Coverings in reconstituted natural stone, authentic finishing, economic and technical solutions. Low water absorption <3%.  
High resistance, low thickness.

### APLICAÇÕES APPLICATIONS

Interior e Exterior  
Pavimentos e Revestimentos  
Coberturas Planas  
Bordaduras de Piscinas

Indoors and Outdoors  
Pavements and Coverings  
Flat Coverings  
Pool Borders

## PRIVATE

PÁG 27-41

### CARACTERÍSTICAS FEATURES

#### Design de Mobiliário e Decoração.

Peças em betão, metal e outros materiais nobres. Especialmente adequados, pela diferenciação estética aliada à elevada resistência, estabilidade e baixa manutenção.

#### Furniture Design and Decoration

Equipment in concrete, metal and other noble materials. Difference in esthetic combined with high resistance, stability and low maintenance.

### APLICAÇÕES APPLICATIONS

Interior e Exterior  
Uso doméstico e hotelaria  
Espaços culturais  
Espaços comerciais

Indoors and Outdoors  
Domestic and Hospitality Use  
Cultural Spaces  
Commercial Spaces



# STONE

STONE

PAVINGS



**STONE CREME** ALC010313006  
CREAM STONE  
40,5x40,5x3,5cm ≈ 83Kg/m<sup>2</sup>

**STONE CREME** ALC010313006  
CREAM STONE  
40,5x20,25x3,5cm ≈ 83Kg/m<sup>2</sup>





# CALÇADA ALTERNATIVA

ALTERNATIVE FOOTPATH

PAVINGS



**CALÇADA ALTERNATIVA** ALC010817003 (CAN)  
ALTERNATIVE FOOTPATH  
Área 0,0612 m<sup>2</sup>



**FAIXA 2** ALC010836001 (F2CAN)  
STRIP 2  
≈ 36x12cm



**Recomendamos** o rejunte da calçada, alternativa que recria de forma mais autêntica a calçada portuguesa.

**We recommend the use** of the mortar on footpath joint to recreate more authentically the portuguese footpath.



[www.amop.eu/pavings](http://www.amop.eu/pavings)



# LAJETA ARDÓSIA

SLATE SLAB

PAVINGS



## ARDÓSIA CREME ALC010620006 (LB208)

CREAM SLATE

40x40x3cm  $\approx$  69Kg/m<sup>2</sup>

40x60x4,2cm  $\approx$  94Kg/m<sup>2</sup>

## ARDÓSIA NEGRO ALC010620001 (LB208)

BLACK SLATE

40x40x3cm  $\approx$  69Kg/m<sup>2</sup>

40x60x4,2cm  $\approx$  94Kg/m<sup>2</sup>

Aconselha-se protector de superfície hidrofugante para pigmentação e uniformização da cor: **Treatcrete CCP**

*It is recommended the use of surface treatment for pigmentation and colour uniformity: **Treatcrete CCP***





# RELEVO POLIDO

POLISHED SURFACE

PAVINGS



**RELEVO POLIDO 204** ALC010102  
 POLISHED SURFACE  
 003 Branco / 001 Preto / 004 Granito Amarelo  
 003 White / 001 Black / 004 Yellow Granite  
 40x40x3cm ≈ 69Kg/m<sup>2</sup>

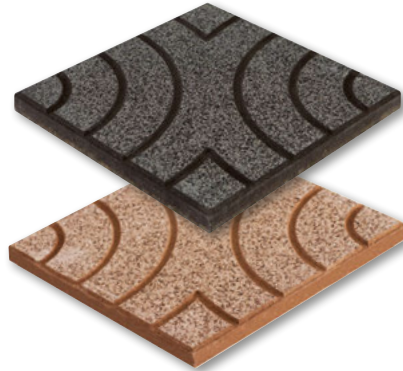

**RELEVO POLIDO 207** ALC010103  
 POLISHED SURFACE  
 001 Preto / 002 Castanho  
 001 Black / 002 Brown  
 40x40x3cm ≈ 69Kg/m<sup>2</sup>



**RELEVO POLIDO 209** ALC010105  
 POLISHED SURFACE  
 001 Preto  
 001 Black  
 40x40x3cm ≈ 69Kg/m<sup>2</sup>



[www.amop.eu/pavings](http://www.amop.eu/pavings)



# LAJETAS LAVADA, BUJARDADA, BETÃO

WASHED, HAMMERED, CONCRETE SLABS



**LAJETA LAVADA SEIXO CASTANHO** ALC010515011 (LL410)  
BROWN PEBBLE WASHED SLAB

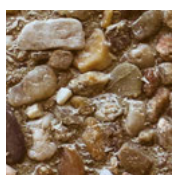

**LAJETA BUJARDADA PRETO** ALC010414001 (BJ101)  
BLACK HAMMERED SLAB

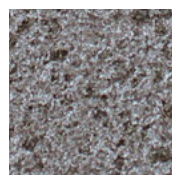

**LAJETA LAVADA GRANITO AMARELO** ALC010515004 (LL455)  
YELLOW GRANITE WASHED SLAB

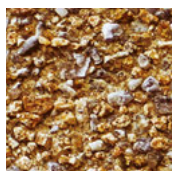

**LAJETA LAVADA PEDRA LIOZ CREME** ALC010515048 (LL424)  
LIOZ STONE WASHED SLAB



**Todas as Lajetas estão disponíveis nas dimensões:**

*All slabs are available in dimensions:*

40x40x3cm ≈ 69Kg/m<sup>2</sup>

40x60x4,2cm ≈ 94Kg/m<sup>2</sup>



**9 mm SEPARADOR**  
9 mm SEPARATOR  
Ref. ALC041026

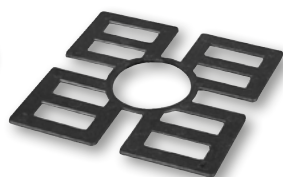

**2 mm REGULADOR**  
2 mm REGULATOR  
Ref. ALC041529



**LAJETA LAVADA PEDRA LIOZ VERMELHA** ALC010515019 (LL440)  
RED LIOZ STONE WASHED SLAB

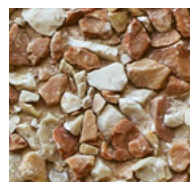



**LAJETA BUJARDADA CINZA** ALC010414005 (BJ103)  
GREY HAMMERED SLAB



**LAJETA BUJARDADA BRANCO** ALC010414003 (BJ107)  
WHITE HAMMERED SLAB



**LAJETA BETÃO CINZA** ALC010618005 (LB400)  
GREY CONCRETE SLAB



**LAJETA BETÃO BRANCO** ALC010618003 (LB400)  
WHITE CONCRETE SLAB



**STRUKTURIT AMARELO** ALC010625009 (LB465)  
STRUKTURIT YELLOW



**STRUKTURIT BRANCO** ALC010625003 (LB465)  
STRUKTURIT WHITE



## STEP PARTS

Disponível em todos os acabamentos bujardados e lavados.  
Available in all hammered and washed finishes.



1.

### COBERTOR STANDARD

STANDART STEP

60x30x4cm ≈ 17kg/un

### COBERTOR POR MEDIDA

BESPOKEN STEP

Medidas máximas / Maximum measures

Comp. / Length 150cm, Larg. / Width 35cm, Esp. / Thickness 4cm  
≈ 52kg (34,5kg/ml)



2.

### ESPELHO STANDARD

RISER

60x13x4cm ≈ 7,5kg/un

### ESPELHO POR MEDIDA

BESPOKEN RISER

Medidas máximas / Maximum measures

Comp. / Length 150cm (máx.), Larg. / Width 13cm, Esp. / Thickness 4cm  
≈ 19kg (12,5kg/ml)

# DEGRAU E RODAPÉ MONOK

## STEP PARTS AND SKIRTING-BOARD

Disponível em todos os acabamentos.  
Available in all finishes.

1.

### COBERTOR

STEP

58x30x2,5 cm ≈ 62Kg/m<sup>2</sup>

60x30x2,5 cm ≈ 62Kg/m<sup>2</sup>

2.

### ESPELHO

RISER

58x15x2,5 cm ≈ 62Kg/m<sup>2</sup>

60x15x2,5 cm ≈ 62Kg/m<sup>2</sup>

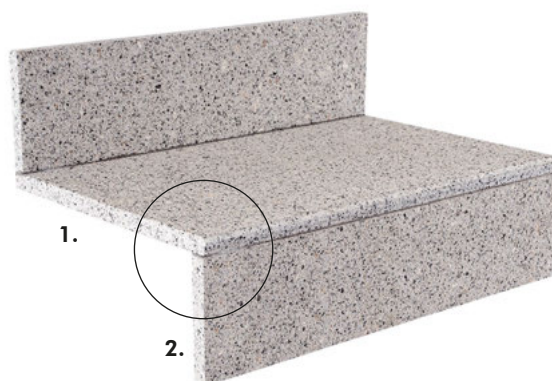

Pormenor 1 e 2  
Detail 1 and 2

3.

### RODAPÉ

SKIRTING-BOARD

Medidas máximas / Maximum measures

38x9x2,5 cm ≈ 62Kg/m<sup>2</sup>

3.



Pormenor 3  
Detail 3



# ACESSÓRIOS PISCINAS

MONOK

## POOL ACCESSORIES

Disponível em LONGUS, TOSKANA E GRANALHADUS.

Available in LONGUS, TOSKANA, GRANALHADUS.



**BORDADURA**  
BORDER  
60x40x2,5 cm



**CUNHA**  
WEDGE  
14/10x40x2,5 cm  
Diam. 200cm



**CANTO CONVEXO**  
CONVEX CORNER  
40x40x2,5 cm



**CANTO CÔNCAVO RECTO (CONJUNTO)**  
CONCAVE CORNER (SET)  
60x60x2,5 cm



**CANTO CÔNCAVO REDONDO (CONJUNTO)**  
ROUND CONCAVE CORNER (SET)  
Raio / Radius 5 / 10 / 15cm



### VANTAGENS AMOP

- Antiderrapante
- Bujardado suave
- Segurança superior
- Conforto pedonal
- Sem desníveis
- Bordadura integrada

### AMOP BENEFITS

- Non-slip
- Soft sandblasted
- Higher security
- Pedestrian comfort
- Leveled surface
- Integrated border



[www.amop.eu/monok](http://www.amop.eu/monok)

# LONGUS

LONGUS

MONO K



**LONGUS CINZA CLARO** MDJ2030426

*LONGUS LIGHT GREY*

40x60x2,5 cm / 60x60x2,5 cm

≈ 62Kg/m<sup>2</sup>



**LONGUS BRANCO DUNAS** MDJ2030401

*LONGUS WHITE DUNAS*

40x60x2,5 cm / 60x60x2,5 cm

≈ 62Kg/m<sup>2</sup>



**LONGUS CREME** MDJ2030424

*LONGUS CREAM*

40x60x2,5 cm / 60x60x2,5 cm

≈ 62Kg/m<sup>2</sup>





# TOSKANA

MONOK

TOSKANA

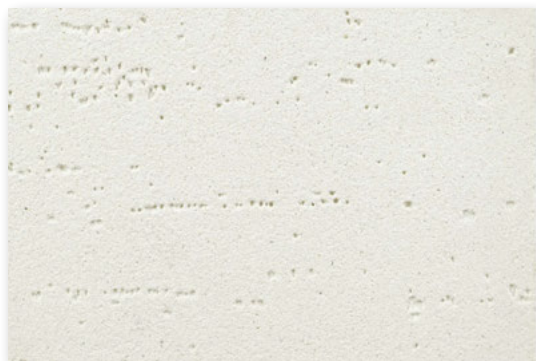

**TOSKANA BRANCO DUNAS** MDJ2030501  
 TOSKANA WHITE DUNAS  
 40x60x2,5 cm / 60x60x2,5 cm  
 ≈ 62Kg/m<sup>2</sup>

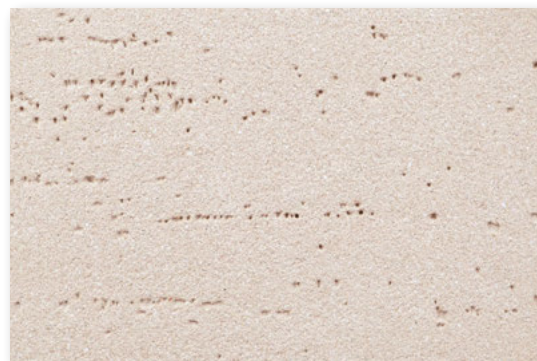

**TOSKANA CREME MARFIM** MDJ2030513  
 TOSKANA CREAM IVORY  
 40x60x2,5 cm / 60x60x2,5 cm  
 ≈ 62Kg/m<sup>2</sup>



**TOSKANA AMARELO OURO** MDJ2030514  
 TOSKANA YELLOW GOLD  
 40x60x2,5 cm / 60x60x2,5 cm  
 ≈ 62Kg/m<sup>2</sup>





# GRANALHADUS

MONO K

GRANALHADUS



**GRANALHADUS BRANCO DUNAS** MDJ2020401  
GRANALHADUS WHITE DUNAS  
40x60x2,5cm / 60x60x2,5cm ≈ 62Kg/m<sup>2</sup>



**GRANALHADUS GRANITO BEIRÃO** MDJ2020411  
GRANALHADUS BEIRÃO GRANITE  
40x60x2,5cm / 60x60x2,5cm ≈ 62Kg/m<sup>2</sup>



**GRANALHADUS GRANITO REAL** MDJ2020410  
GRANALHADUS ROYAL GRANITE  
40x60x2,5cm / 60x60x2,5cm ≈ 62Kg/m<sup>2</sup>



**GRANALHADUS LIOZ BRANCO** MDJ2020426  
GRANALHADUS WHITE LIOZ  
40x60x2,5cm / 60x60x2,5cm ≈ 62Kg/m<sup>2</sup>



**GRANALHADUS LIOZ CINZA** MDJ2020425  
GRANALHADUS GREY LIOZ  
40x60x2,5cm / 60x60x2,5cm ≈ 62Kg/m<sup>2</sup>



**GRANALHADUS NEGRO FRÁGUAS** MDJ2020402  
GRANALHADUS BLACK FRÁGUAS  
40x60x2,5cm / 60x60x2,5cm ≈ 62Kg/m<sup>2</sup>



**GRANALHADUS PEDRAS SALGADAS** MDJ2020415  
GRANALHADUS PEDRAS SALGADAS  
40x60x2,5cm / 60x60x2,5cm ≈ 62Kg/m<sup>2</sup>



**GRANALHADUS VERDE** MDJ2020418  
GRANALHADUS GREEN  
40x60x2,5cm / 60x60x2,5cm ≈ 62Kg/m<sup>2</sup>



**GRANALHADUS VERMELHO** MDJ2020417  
GRANALHADUS RED  
40x60x2,5cm / 60x60x2,5cm ≈ 62Kg/m<sup>2</sup>



# TIRA em LONGUS, TOSKANA ou GRANALHADUS

LONGUS TOSKANA OR GRANALHADUS STRIP

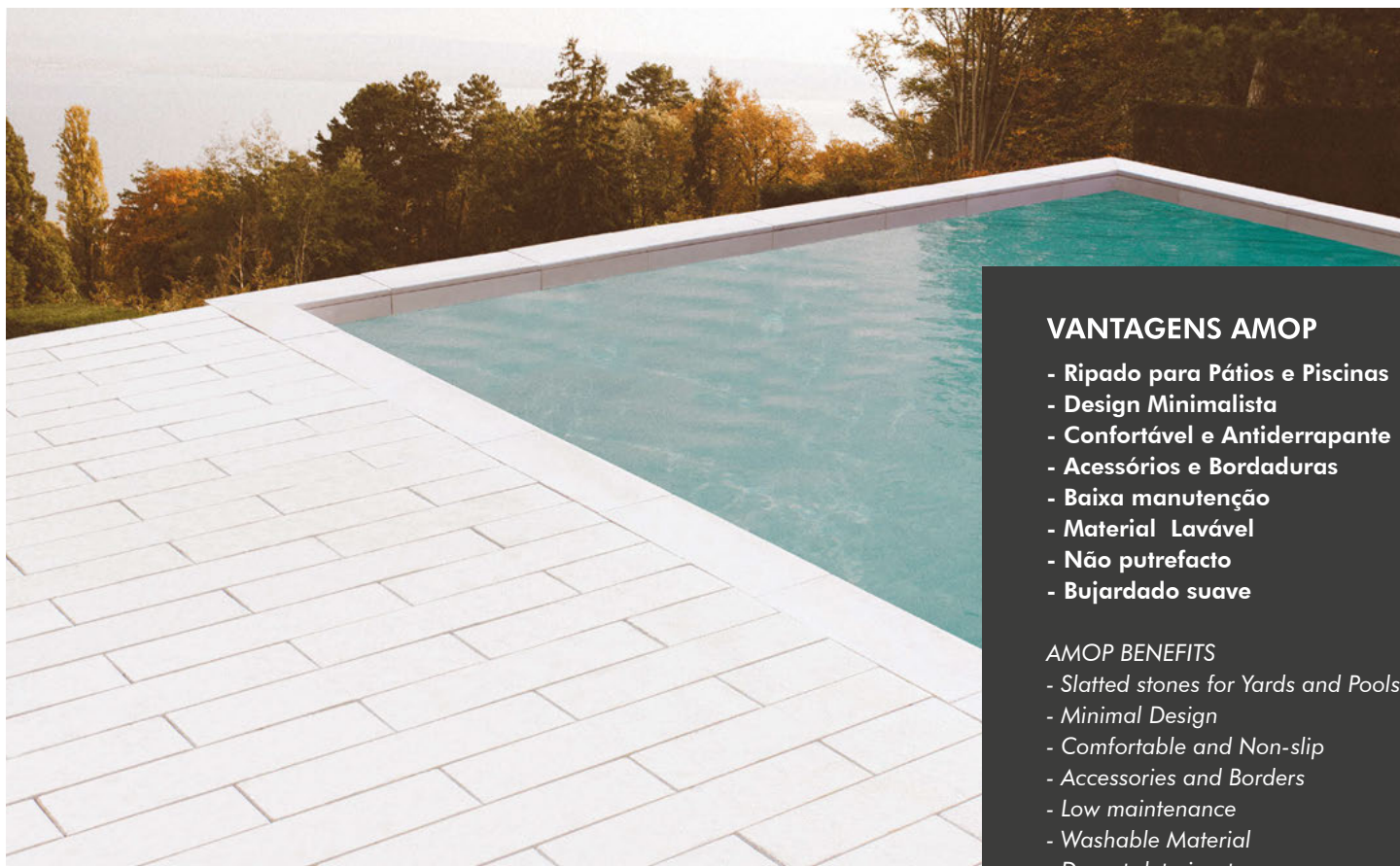

## VANTAGENS AMOP

- Ripado para Pátios e Piscinas
- Design Minimalista
- Confortável e Antiderrapante
- Acessórios e Bordaduras
- Baixa manutenção
- Material Lavável
- Não putrefacto
- Bujardado suave

## AMOP BENEFITS

- Slatted stones for Yards and Pools
- Minimal Design
- Comfortable and Non-slip
- Accessories and Borders
- Low maintenance
- Washable Material
- Do not deteriorate
- Soft sandblasted



### TIRA LONGUS

LONGUS STRIP

60x14.2x2.5cm ≈ 62Kg/m<sup>2</sup>



### TIRA TOSKANA

TOSKANA STRIP

60x14.2x2.5cm ≈ 62Kg/m<sup>2</sup>

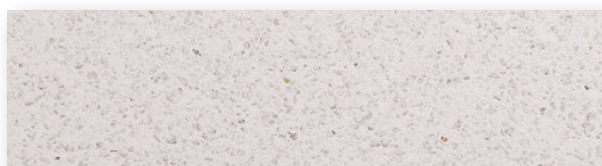

### TIRA GRANALHADUS

GRANALHADUS STRIP

60x14.2x2.5cm ≈ 62Kg/m<sup>2</sup>

**Topos não serrados**

Non-sawed top parts

Disponível em todas as cores do LONGUS, TOSKANA E GRANALHADUS.  
Available in all colors of LONGUS, TOSKANA E GRANALHADUS.



[www.amop.eu/monok](http://www.amop.eu/monok)

# DISTINTUS DESBASTADO

MONO K

DISTINTUS ROUGH



**BRANCO DUNAS DESBASTADO** MDJ1020101

WHITE DUNAS ROUGH

40x60x2,5 cm / 60x60x2,5 cm

≈ 62Kg/m<sup>2</sup>



**NEGRO FRÁGUAS DESBASTADO** MDJ1020102

BLACK FRÁGUAS ROUGH

40x60x2,5 cm / 60x60x2,5 cm

≈ 62Kg/m<sup>2</sup>

Disponível em vários acabamentos:  
Available in different finishes:

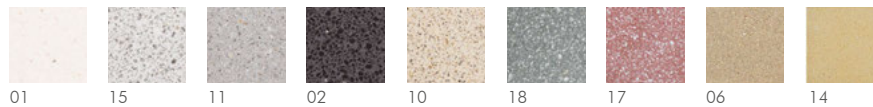

## VANTAGENS AMOP

- Liso Antiderrapante
- Efeito Pedra serrada
- Baixa absorção

## AMOP BENEFITS

- Non-slip smooth
- Sawn Effect
- Low absorption



# DISTINTUS ACETINADO

MONOK

*DISTINTUS BRUSHED*



**BRANCO DUNAS ACETINADO** MDJ4020101

*WHITE DUNAS BRUSHED*

40x60x2,5 cm / 60x60x2,5 cm

≈ 62Kg/m<sup>2</sup>

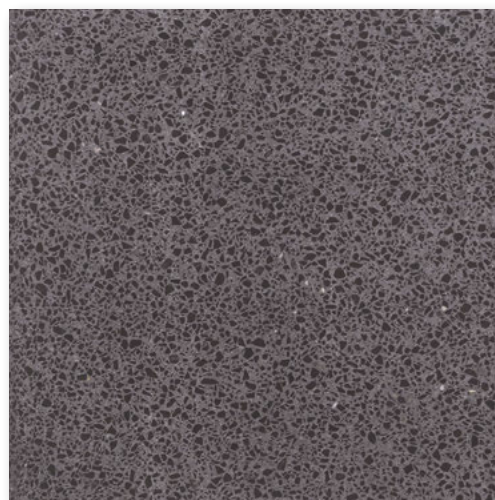

**NEGRO FRÁGUAS ACETINADO** MDJ4020102

*BLACK FRÁGUAS BRUSHED*

40x60x2,5 cm / 60x60x2,5 cm

≈ 62Kg/m<sup>2</sup>

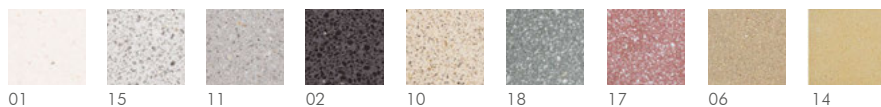

01

15

11

02

10

18

17

06

14



## VANTAGENS AMOP

- Utilização interior
- Limpeza fácil c/ esfregona
- Liso antiderrapante suave
- Aparência meio brilho

## AMOP BENEFITS

- Indoor use
- Easy cleaning with mop
- Smooth non-slip
- Semi shine aspect



[www.amop.eu/monok](http://www.amop.eu/monok)

# ESTILHADUS

ESTILHADUS

MONO K



**ESTILHADUS GRANITO REAL** MDJ2020310

*ESTILHADUS ROYAL GRANITE*

38x58x2,5 cm ≈ 62Kg/m<sup>2</sup>

58x58x2,5 cm ≈ 62Kg/m<sup>2</sup>



**ESTILHADUS GRANITO BEIRÃO** MDJ2020311

*ESTILHADUS BEIRÃO GRANITE*

38x58x2,5 cm ≈ 62Kg/m<sup>2</sup>

58x58x2,5 cm ≈ 62Kg/m<sup>2</sup>



**ESTILHADUS PEDRAS SALGADAS** MDJ2020315

*ESTILHADUS PEDRAS SALGADAS GRANITE*

38x58x2,5 cm ≈ 62Kg/m<sup>2</sup>

58x58x2,5 cm ≈ 62Kg/m<sup>2</sup>



## VANTAGENS AMOP

- Antiderrapante
- Bujardado forte
- Arestas serradas
- Efeito pedra martelada
- Baixa absorção de água

## AMOP BENEFITS

- Non-slip
- Strong sandblasted
- Sawn edges
- Hammered stone effect
- Low water absorption



# TIRA ESTILHADUS

ESTILHADUS STRIP

MONO K



## TIRA ESTILHADUS BRANCO DUNAS

STRIP ESTILHADUS WHITE DUNAS

58x7x2,5 / 58x9x2,5 cm

≈ 62Kg/m<sup>2</sup>

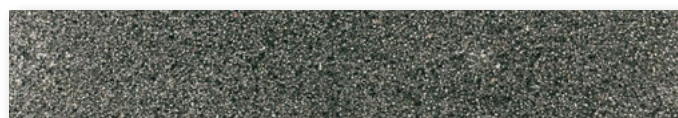

## TIRA ESTILHADUS NEGRO FRÁGUAS

STRIP ESTILHADUS BLACK FRÁGUAS

58x7x2,5 / 58x9x2,5 cm

≈ 62Kg/m<sup>2</sup>



## TIRA ESTILHADUS GRANITO REAL

STRIP ESTILHADUS ROYAL GRANITE

58x7x2,5 / 58x9x2,5 cm

≈ 62Kg/m<sup>2</sup>



## TIRA ESTILHADUS GRANITO BEIRÃO

STRIP ESTILHADUS BEIRÃO GRANITE

58x7x2,5 / 58x9x2,5 cm

≈ 62Kg/m<sup>2</sup>



# DIAGONAL

DIAGONAL

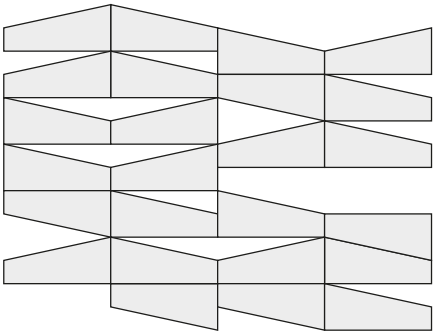

1.

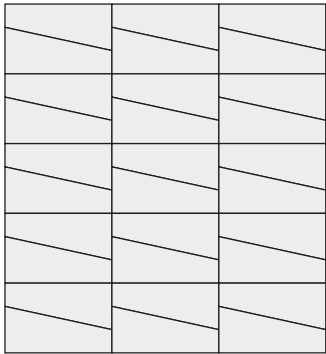

2.

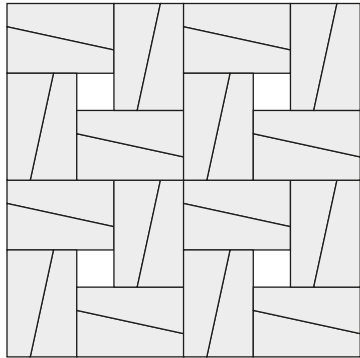

3.

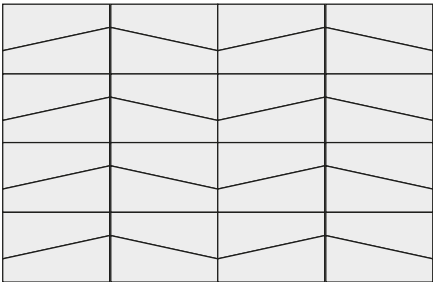

4.

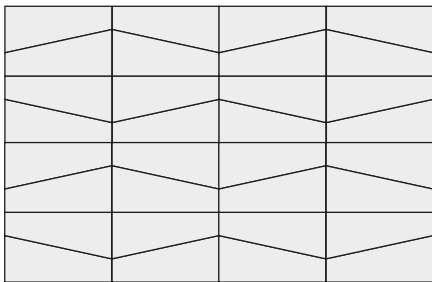

5.

**PEÇA DIREITA**  
RIGHT SLAB



**PEÇA ESQUERDA**  
LEFT SLAB





**DIAGONAL BRANCO DUNAS DESBASTADO**

MDJ1020101D1582525

DIAGONAL WHITE DUNAS ROUGH

58x25,33 cm / 12,67x2,5cm ≈ 62Kg/m<sup>2</sup>



**DIAGONAL GRANITO REAL DESBASTADO**

MDJ1020110D1582525

DIAGONAL ROYAL GRANITE ROUGH

58x25,33 cm / 12,67x2,5cm ≈ 62Kg/m<sup>2</sup>



**DIAGONAL NEGRO FRÁGUAS DESBASTADO**

MDJ1020102D1582525

DIAGONAL BLACK FRÁGUAS ROUGH

58x25,33 cm / 12,67x2,5cm ≈ 62Kg/m<sup>2</sup>



**DIAGONAL GRANITO BEIRÃO DESBASTADO**

MDJ1020111D1582525

DIAGONAL BEIRÃO GRANITE ROUGH

58x25,33 cm / 12,67x2,5cm ≈ 62Kg/m<sup>2</sup>

**DESBASTADO**  
ROUGH



**ESTILHADUS**  
HAMMERED



**DIAGONAL ESTILHADUS BRANCO DUNAS**

MDJ2020301D1582525

DIAGONAL ESTILHADUS WHITE DUNAS

58x25,33 cm / 12,67x2,5cm ≈ 62Kg/m<sup>2</sup>



**DIAGONAL ESTILHADUS GRANITO REAL**

MDJ2020310D1582525

DIAGONAL ESTILHADUS ROYAL GRANITE

58x25,33 cm / 12,67x2,5cm ≈ 62Kg/m<sup>2</sup>



**DIAGONAL ESTILHADUS NEGRO FRÁGUAS**

MDJ2020302D1582525

DIAGONAL ESTILHADUS BLACK FRÁGUAS

58x25,33 cm / 12,67x2,5cm ≈ 62Kg/m<sup>2</sup>



**DIAGONAL ESTILHADUS GRANITO BEIRÃO**

MDJ2020311D1582525

DIAGONAL ESTILHADUS BEIRÃO GRANITE

58x25,33 cm / 12,67x2,5cm ≈ 62Kg/m<sup>2</sup>





# MULTI TIRA

MULTI STRIP

MONO K

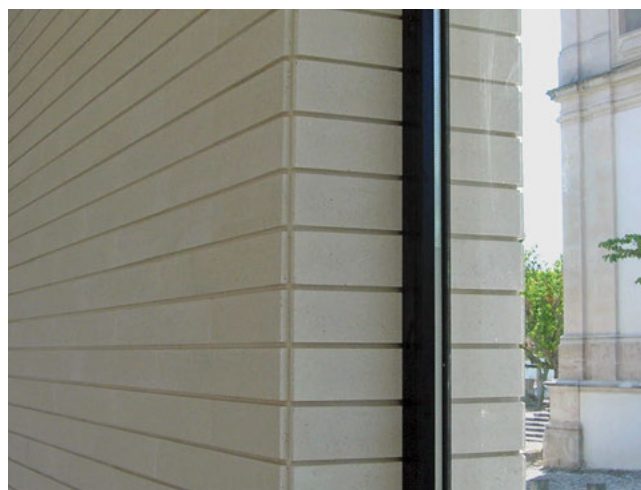

## MULTI TIRA DISTINTUS DESBASTADO

MULTI STRIP DISTINTUS ROUGH

38x58x2,5 cm,  $\approx 62\text{Kg/m}^2$

Disponível em todas as referências.  
Available in all references.

# TIBURTINUS

TIBURTINUS

MONOK

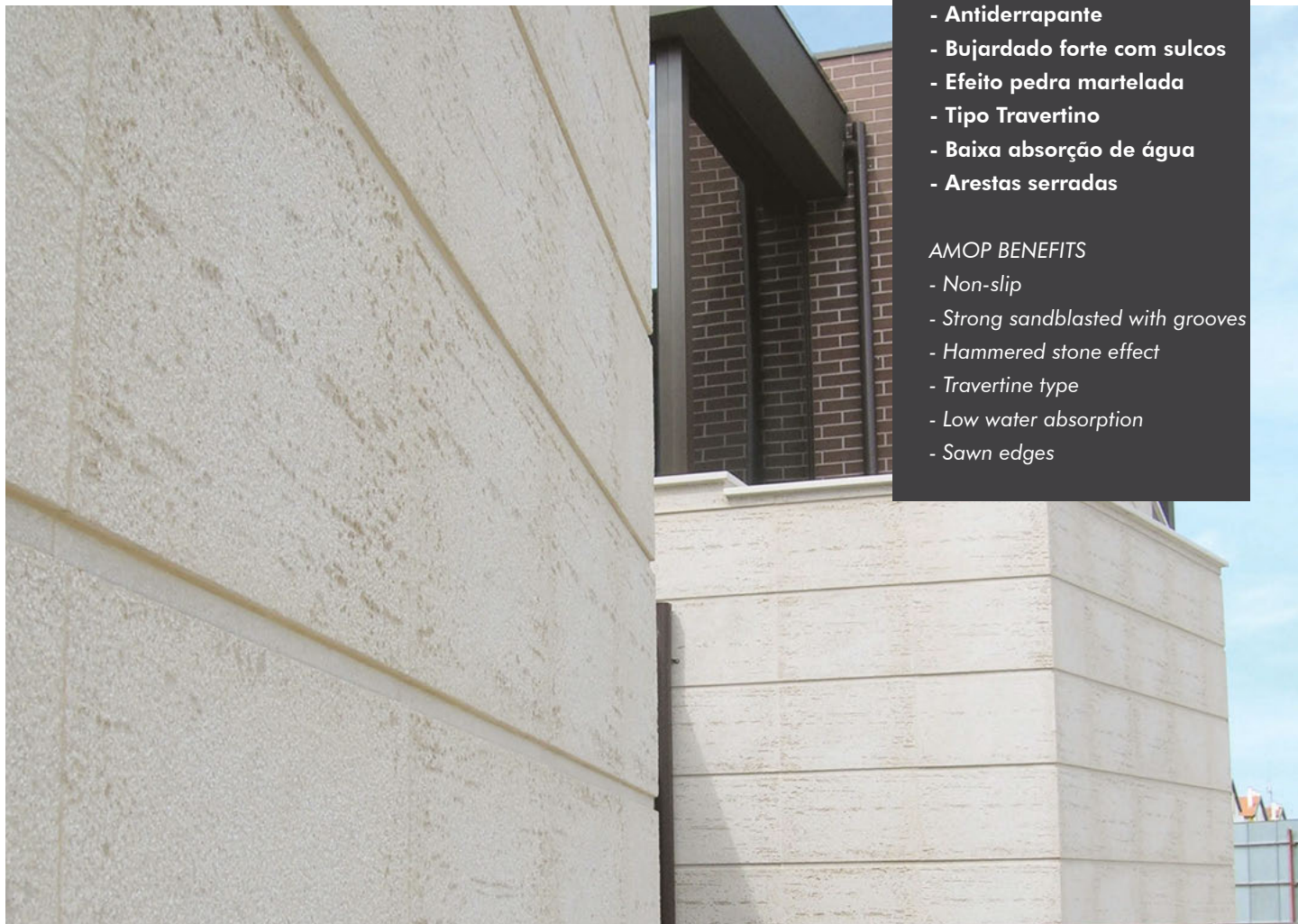

## VANTAGENS AMOP

- Antiderrapante
- Bujardado forte com sulcos
- Efeito pedra martelada
- Tipo Travertino
- Baixa absorção de água
- Arestas serradas

## AMOP BENEFITS

- Non-slip
- Strong sandblasted with grooves
- Hammered stone effect
- Travertine type
- Low water absorption
- Sawn edges



**TIBURTINUS CREME MARFIM** MDJ2030213

TIBURTINUS CREAM IVORY  
38x58x2,5 cm / 58x58x2,5 cm  
≈ 62Kg/m<sup>2</sup>



**TIBURTINUS NEGRO FRÁGUAS** MDJ2030202

TIBURTINUS BLACK FRÁGUAS  
38x58x2,5 cm / 58x58x2,5 cm  
≈ 62Kg/m<sup>2</sup>



# THERMAL SOLUTIONS

THERMAL SOLUTIONS

MONO K

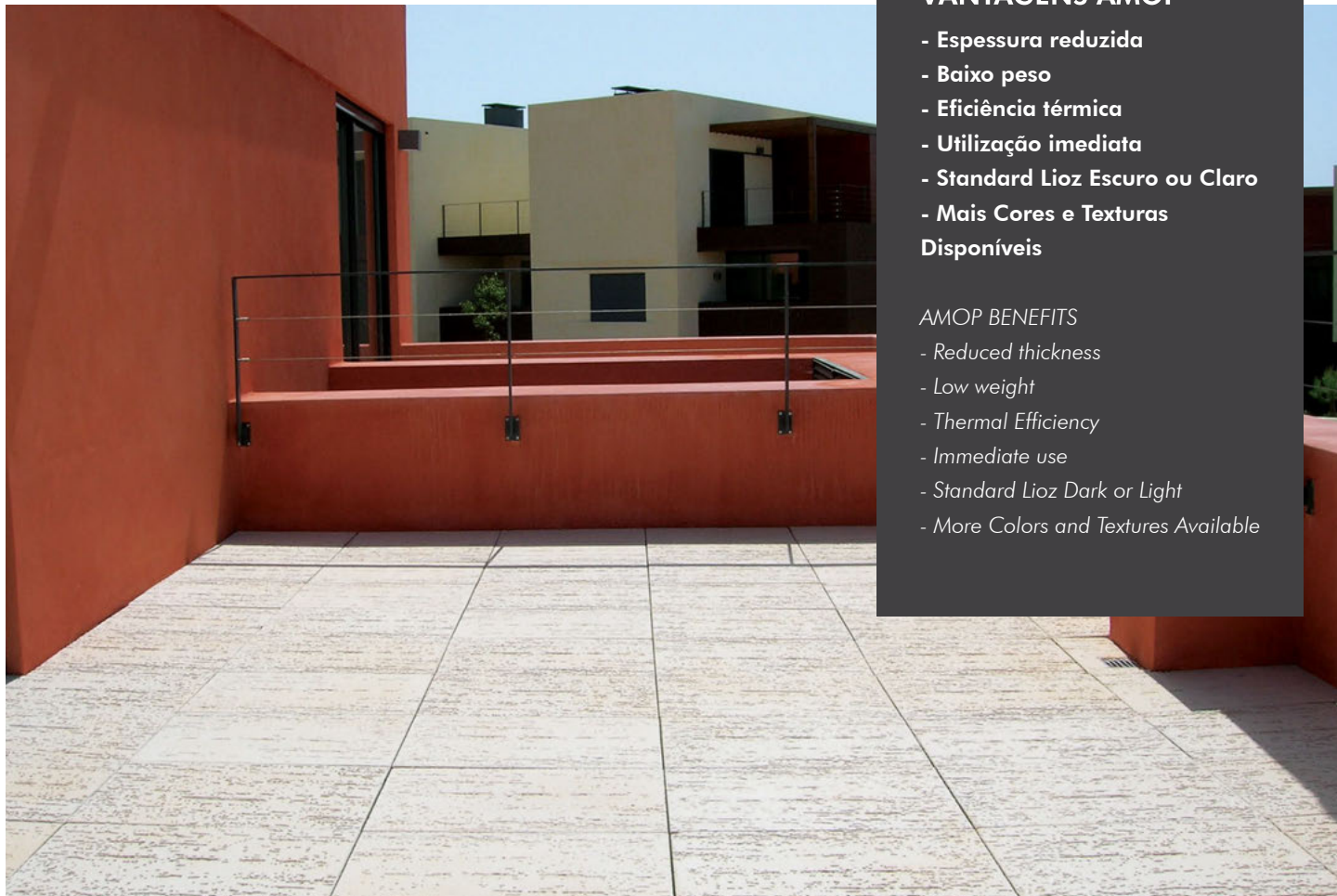

## VANTAGENS AMOP

- Espessura reduzida
- Baixo peso
- Eficiência térmica
- Utilização imediata
- Standard Lioz Escuro ou Claro
- Mais Cores e Texturas Disponíveis

## AMOP BENEFITS

- Reduced thickness
- Low weight
- Thermal Efficiency
- Immediate use
- Standard Lioz Dark or Light
- More Colors and Textures Available

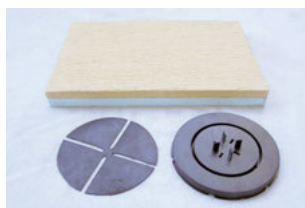

Disponível para toda a gama MONO K  
Available for all MONO K products

**PEDRA MONO K**  
MONO K STONE

**ISOLAMENTO**  
ISOLATION

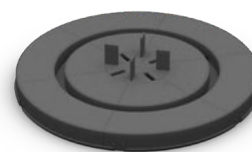

**THERMAL SOLUTIONS**  
40x60cm / 38x58cm / 60x60cm / 58x58cm  
Espessura do Isolamento 3, 4, 5, 6 e 8cm  
Thickness 3, 4, 5, 6 and 8mm

**APOIO LARGO PARA MONO K MDJ8000000AL**  
LARGE SUPPORT FOR MONO K

# LIMPEZA E PROTEÇÃO

CLEANING AND PROTECTION

amop®  
synergies

As cores constantes neste catálogo são indicativas.  
Todos os produtos cimentícios podem sofrer do fenómeno de eflorescências, sendo um fenómeno natural.  
Recomenda-se a impermeabilização, após a aplicação e limpeza do material.

The colours shown in this catalogue are for guidance only.  
All of the cement products can suffer the phenomenon called efflorescence, this is a natural phenomenon.  
It's recommended the waterproofing treatment, after application and cleaning of the material

**ANTES** Material com eflorescências  
**BEFORE** Material with efflorescences

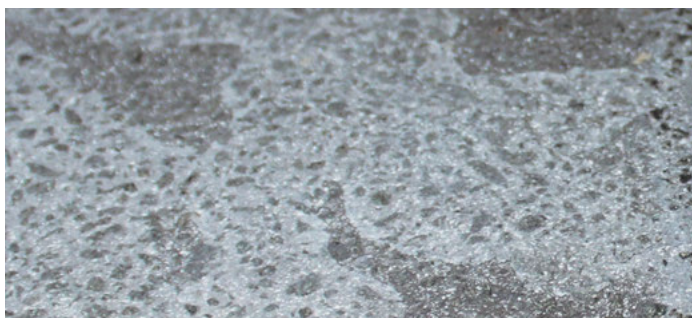

**DEPOIS** Material limpo  
**AFTER** Clean material



**CLEANCRETE AC** Ref. 60001010001



**ANTES** Material não impermeabilizado  
**BEFORE** Non waterproofing material



**DEPOIS** Material impermeabilizado  
**AFTER** Waterproofing material



**TREATSTONE ISP** Ref.60003080001  
Protector hidrófugo e oleófugo, produto repelente à água e aos óleos.  
Hydrophobic and oleophobic protector, water and oil repellent product.





# TIRA TIBURTINUS

MONO K

TIBURTINUS STRIP



## TIRA TIBURTINUS BRANCO DUNAS

TIBURTINUS STRIP WHITE DUNAS

58x7x2,5 cm / 58x9x2,5 cm

≈ 62Kg/m<sup>2</sup>



## TIRA TIBURTINUS NEGRO FÁGUAS

TIBURTINUS STRIP BLACK FRÁGUAS

58x7x2,5 cm / 58x9x2,5 cm

≈ 62Kg/m<sup>2</sup>



## TIRA TIBURTINUS CREME MARFIM

TIBURTINUS STRIP CREAM IVORY

58x7x2,5 cm / 58x9x2,5 cm

≈ 62Kg/m<sup>2</sup>



## TIRA TIBURTINUS AMARELO OURO

TIBURTINUS STRIP YELLOW GOLD

58x7x2,5 cm / 58x9x2,5 cm

≈ 62Kg/m<sup>2</sup>



# TOSCO

TOSCO

PRIVATE



**RECTUS AMARELO** PRAM6T  
RECTUS YELLOW  
≈ 20x10x6 cm 132Kg/m<sup>2</sup>



**RECTUS PRETO** PRPT6T  
RECTUS BLACK  
≈ 20x10x6 cm 132Kg/m<sup>2</sup>



**RECTUS BRANCO** PRBR6T  
RECTUS WHITE  
≈ 20x10x6 cm 132Kg/m<sup>2</sup>

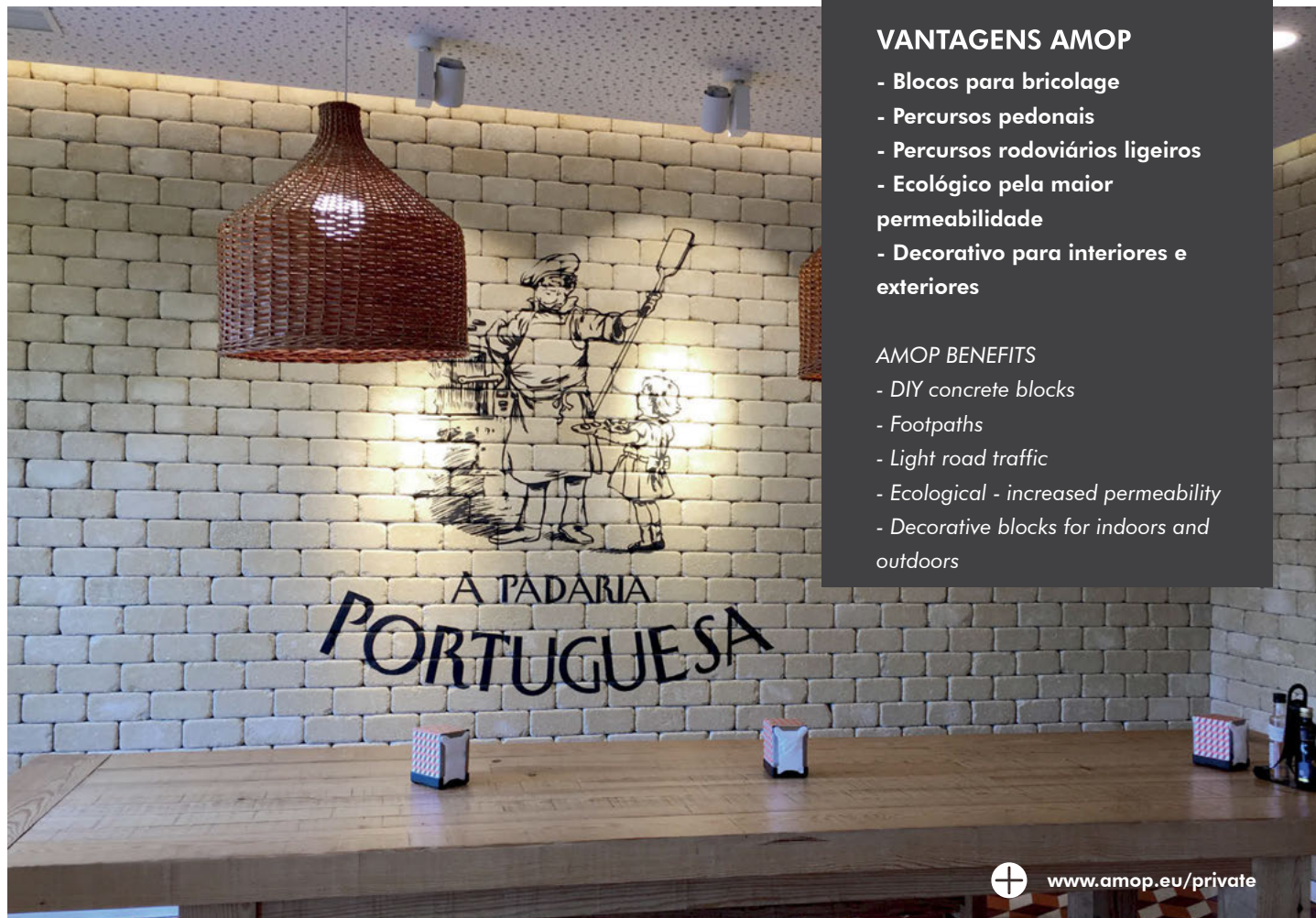

## VANTAGENS AMOP

- Blocos para bricolage
- Percursos pedonais
- Percursos rodoviários ligeiros
- Ecológico pela maior permeabilidade
- Decorativo para interiores e exteriores

## AMOP BENEFITS

- DIY concrete blocks
- Footpaths
- Light road traffic
- Ecological - increased permeability
- Decorative blocks for indoors and outdoors



[www.amop.eu/private](http://www.amop.eu/private)



# PAS JAPONAIS

PRIVATE

PAS JAPONAIS



**PAS JAPONAIS BRANCO**  
WHITE 1802000010101  
≈ 40x51x3cm 12Kg/un



**PAS JAPONAIS PRETO**  
BLACK 1802000010201  
≈ 40x51x3cm 12Kg/un



**PAS JAPONAIS CINZA**  
GREY 1802000010701  
≈ 40x51x3cm 12Kg/un



**PAS JAPONAIS CREME**  
CREAM 1802000011001  
≈ 40x51x3cm 12Kg/un



**PAS JAPONAIS AMARELO**  
YELLOW 1802000011101  
≈ 40x51x3cm 12Kg/un



**PAS JAPONAIS CASTANHO**  
BROWN 1802000010301  
≈ 40x51x3cm 12Kg/un





# PEDRAS DECORATIVAS

DECORATIVE STONES

PRIVATE



**MÁRMORE BRANCO ROLADO** AG0101001

ROLLED WHITE MARBLE

2/4 , 3/6 , 6/10 cm



**BASALTO ROLADO** AG0301000

ROLLED BASALT

2/4 , 3/6 , 6/10 cm



**GRAVILHA XISTO PRETO** AG1506013

GRAVEL SHALE BLACK

2/4 , 3/6 cm



**SEIXO** AG0600000

RIVER STONE

2/4 , 3/6 cm



## VANTAGENS AMOP

- Percursos pedonais
- Proteção das plantas
- Decoração do Jardim
- Elegância
- Solução económica
- Durabilidade
- Sem manutenção

## AMOP BENEFITS

- Footpaths
- Protection of plants
- Garden Decoration
- Elegance
- Economic solution
- Durability
- No maintenance



[www.amop.eu/private](http://www.amop.eu/private)



# CONCRETE DECK

CONCRETE DECK

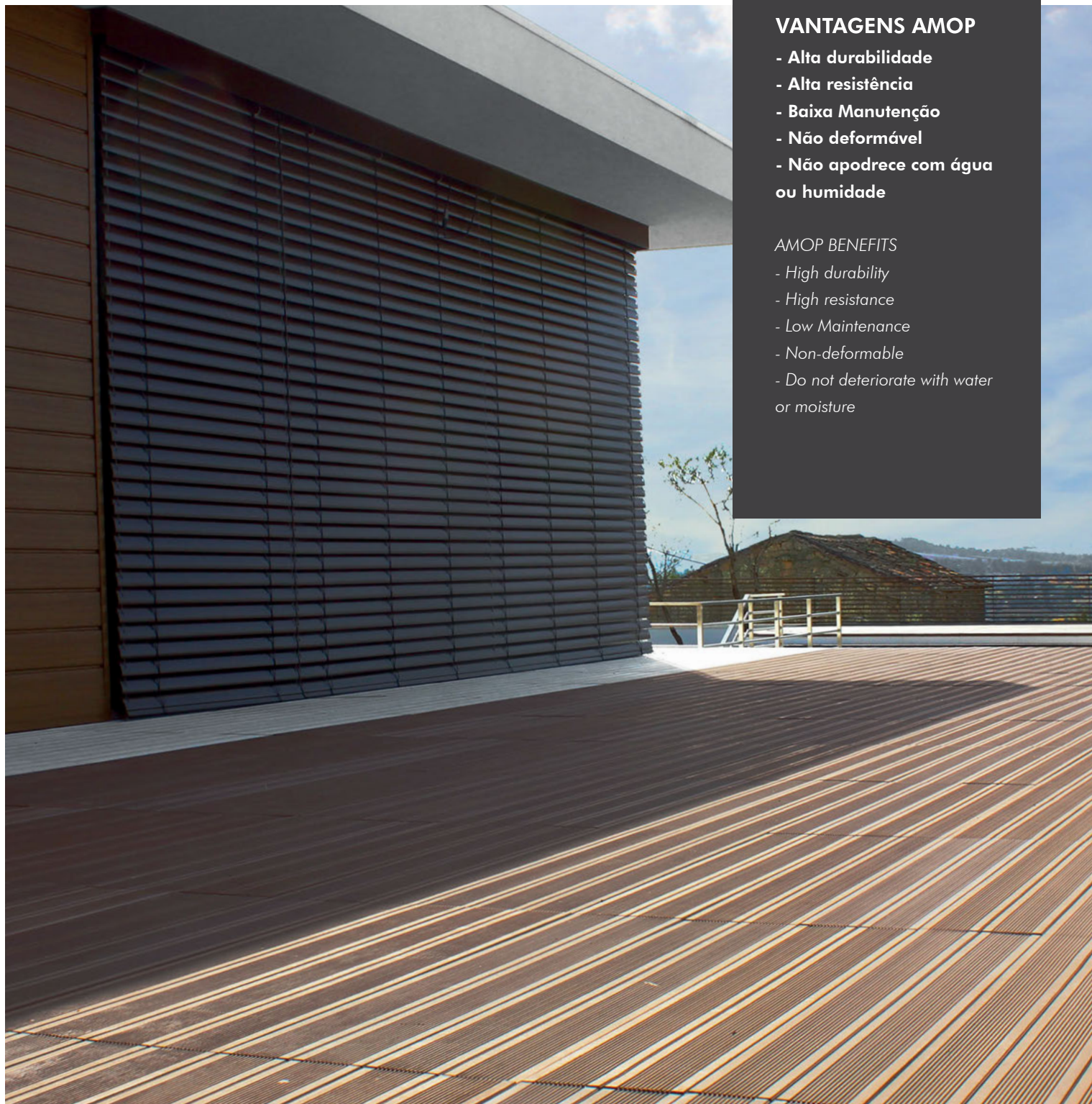

## VANTAGENS AMOP

- Alta durabilidade
- Alta resistência
- Baixa Manutenção
- Não deformável
- Não apodrece com água ou humidade

## AMOP BENEFITS

- High durability
- High resistance
- Low Maintenance
- Non-deformable
- Do not deteriorate with water or moisture

## PEÇA DECK

DECK PIECE

≈ 100x20x4,5 cm

≈ 98,25 Kg/m<sup>2</sup>







**DECK BRANCO** 1802100010101  
WHITE DECK



**DECK PRETO** 1802100010201  
BLACK DECK



**DECK CASTANHO** 1802100010301  
BROWN DECK



**DECK CINZA** 1802100010701  
GREY DECK



**DECK AMARELO** 1802100011101  
YELLOW DECK



**DECK CREME** 1802100011001  
CREAM DECK

**BORDADURA DECK**

DECK BORDER  
≈ 100x30x4,5 cm  
≈ 29,45 Kg/ml





# NODE

NODE

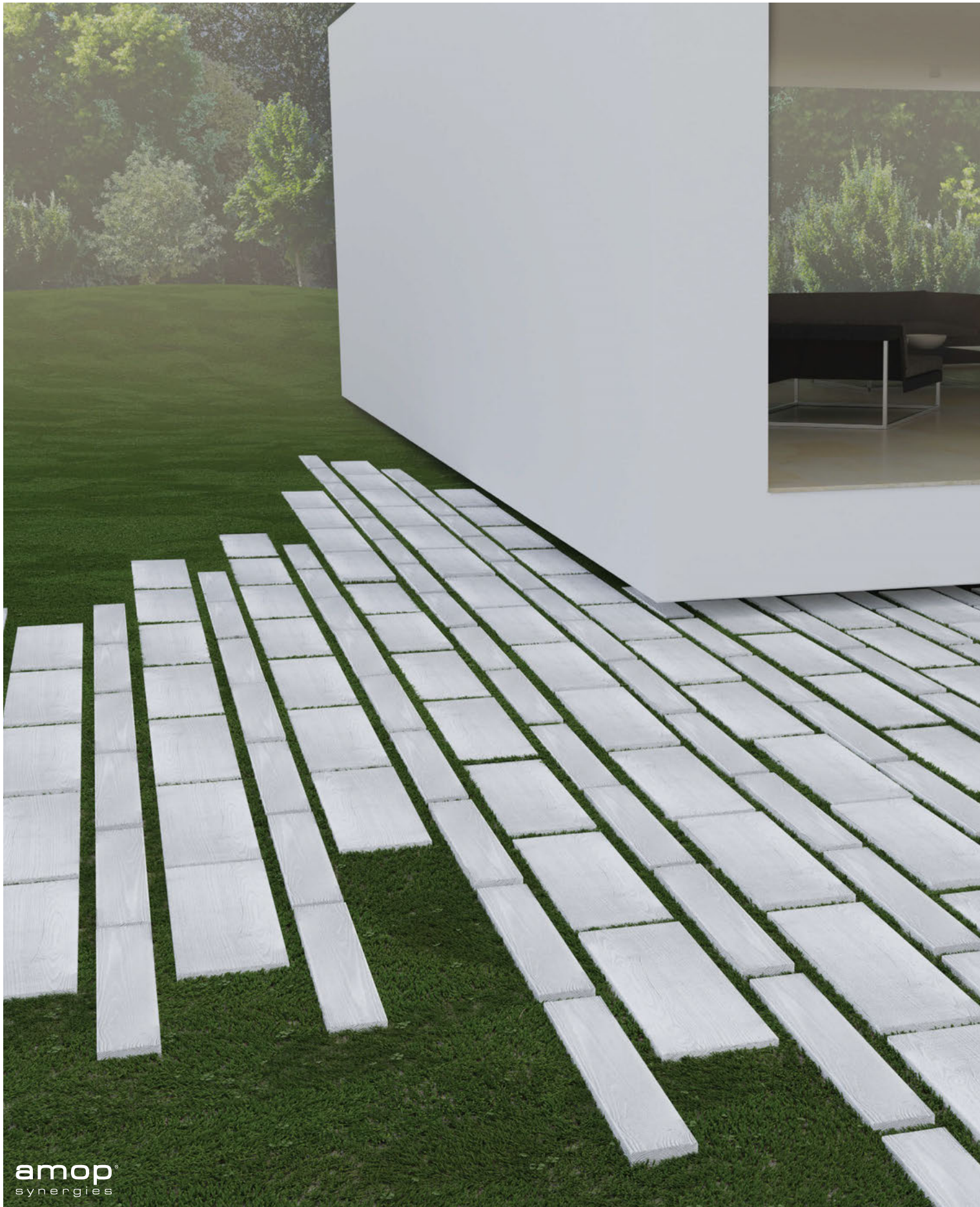

### VANTAGENS AMOP

- Alta durabilidade
- Alta resistência
- Baixa Manutenção
- Não deformável
- Não apodrece com água ou humidade
- Textura da Madeira

#### AMOP BENEFITS

- High durability
- High resistance
- Low Maintenance
- Non-deformable
- Do not deteriorate with water or moisture
- Wood Texture



**NODE 27000010**  
90x15x4cm ≈ 88Kg/m<sup>2</sup>



**NODE 27001010**  
90x30x4cm ≈ 88Kg/m<sup>2</sup>

Cores disponíveis:  
Available in different colours:





# MEGA LAJETAS

MEGA PAVING FLAG

PRIVATE

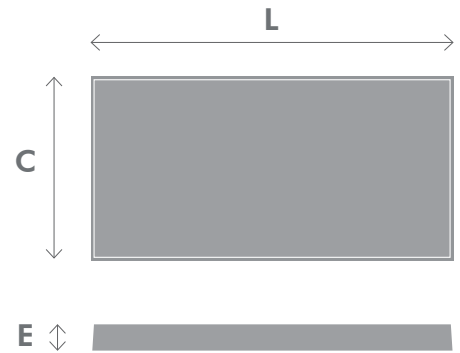

**MEGA LAJETA**  
MEGA-PAVING FLAG  
≈ 150Kg/m<sup>2</sup>

Disponível em vários acabamentos:  
Available in different finishes:

Betão CS Liso  
Cast Stone Smooth



Betão CS Bujardado  
Cast Stone Sandblasted



REF	L cm	C cm	E cm
12001	50	50	6
12002	100	25	6
12003	100	50	6
12004	120	80	6
12005	100	100	6
12019	140	70	6
12006	140	100	6

Outras medidas disponíveis por encomenda.  
Other measures available by request.



## VANTAGENS AMOP

- Alta durabilidade
- Alta resistência
- Baixa Manutenção
- Não deformável
- Não apodrece com água ou humidade

### AMOP BENEFITS

- High durability
- High resistance
- Low Maintenance
- Non-deformable
- Do not deteriorate with water or moisture

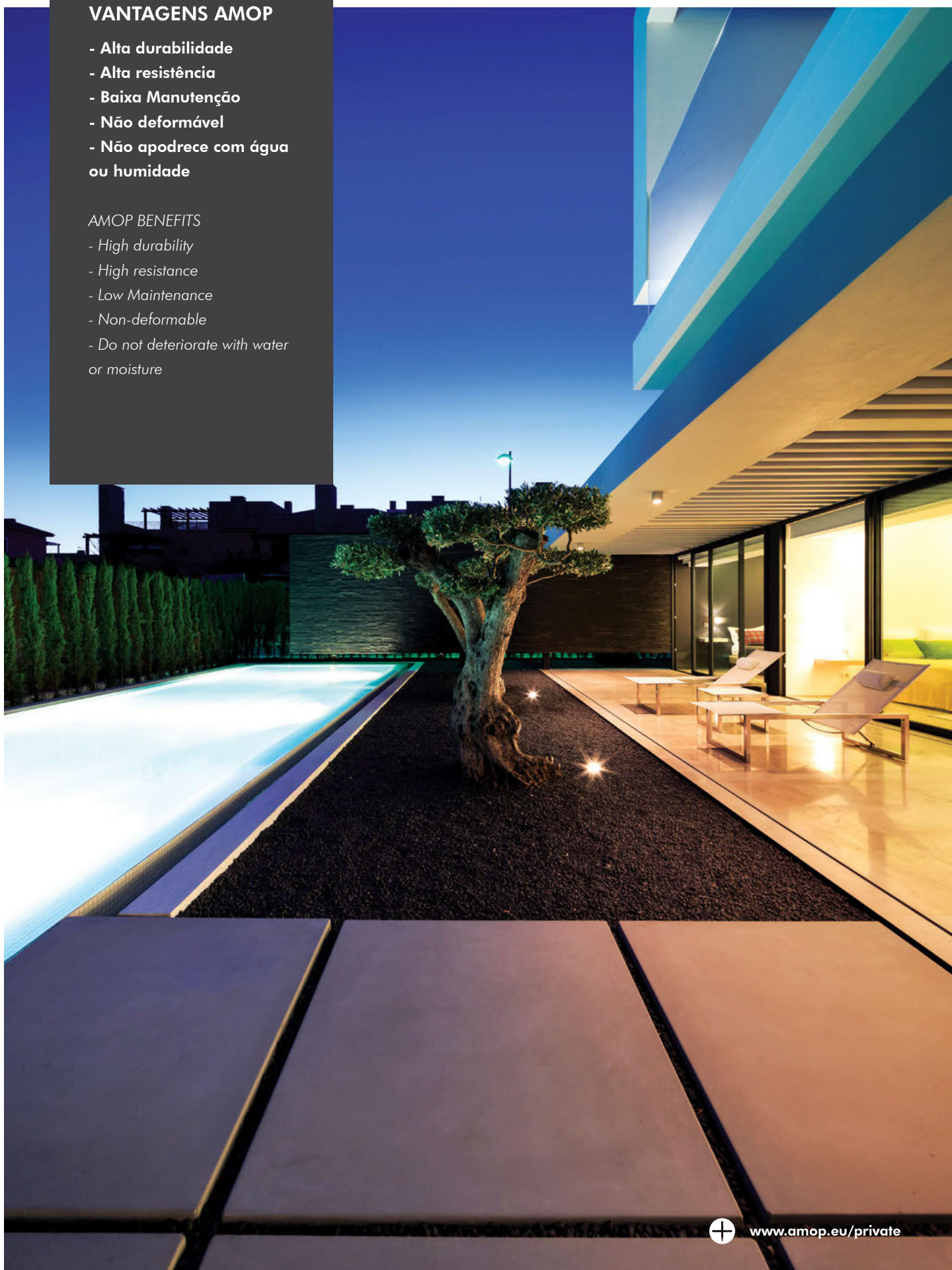



# CONCRETE LIVING

CONCRETE LIVING

Churrasqueira, armazenagem de lenha, bancos, mesas de apoio e floreiras, para compor um espaço de lazer, prático e confortável, com um design neutro e contemporâneo, à medida do seu pátio ou jardim.

*Barbecue, wood storage, benches, tables and planters, to create a practical and comfortable leisure space, with a neutral and contemporary design, customized for your yard or garden.*



**CHURRASQUEIRA 9** 14054  
BARBECUE 9  
140x187x70cm ≈ 550Kg



**CHURRASQUEIRA 8** 14053  
BARBECUE 8  
140x130x70cm ≈ 325Kg  
Grelhador não incluído. Adquirido separadamente.  
*Grill not included. Bought separately.*



**CHURRASQUEIRA 7**  
BARBECUE 7  
14047  
80x130x45cm ≈ 325Kg



**CHURRASQUEIRA 6**  
BARBECUE 6  
14046  
80x187x45cm ≈ 500Kg



**CHURRASQUEIRA 3**  
BARBECUE 3  
14003  
80x227x45cm ≈ 535Kg



**CHURRASQUEIRA 8**  
BARBECUE 8  
14053  
140x130x70cm ≈ 325Kg



**CHURRASQUEIRA 9**  
BARBECUE 9  
14054  
140x187x70cm ≈ 550Kg

### VANTAGENS AMOP

- Durabilidade e Estabilidade
- Linhas modernas
- Fácil conjugação com outros materiais
- Baixa absorção de água
- Acabamento em betão ou pedra aparente

### AMOP BENEFITS

- Durability
- Stability
- Modern lines
- Easily combined with other materials
- Low water abstraction
- Concrete or stone surface finish



Materiais e Acabamentos:  
Materials and finishes:

Betão CS Liso  
Cast Stone Smooth



400 BR 400 CZ

Betão CS Bujardado  
Cast Stone Sandblasted

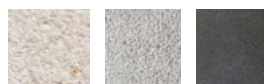

475 445 425

Chapa Forjada Preta  
Forged Black Metal



### MESAS APOIO E BANCOS TABLES AND BENCHES



**MÓDULO CK3** 14032  
MODULE CK3  
40x40x40cm ≈ 55Kg

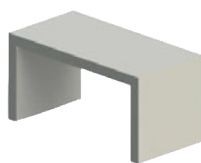

**MÓDULO CK1** 14030  
MODULE CK1  
80x40x40cm ≈ 75Kg



**MÓDULO CK4** 14033  
MODULE  
80x17x40cm ≈ 50Kg

### FLOEIRAS PLANTERS



**FLOEIRA** 14055  
PLANTER  
80x40x40cm ≈ 78Kg



**FLOEIRA** 14056  
PLANTER  
40x40x40cm ≈ 57Kg





# FRAME

PRIVATE

FRAME



**CADEIRA FRAME 29001**  
FRAME CHAIR  
80x80x60cm ≈ 25Kg



**MESA DE APOIO FRAME 29002**  
FRAME SIDE TABLE  
45x45x45cm ≈ 17Kg



**BANCO FRAME 29003**  
FRAME BENCH  
45x45x45cm ≈ 15Kg

Metal Lacado  
Lacquered Metal



# FLOW

FLOW

PRIVATE



**LOUNGE 26002**

LOUNGE

91x88x65cm Base / Base ≈ 80Kg + Assento / Seat ≈ 50Kg



**CHAISE 26001**

CHAISE

180x56x65cm Base / Base ≈ 85Kg + Assento / Seat ≈ 75Kg



**MESA LOUNGE 26003**

LOUNGE TABLE

80x37,5x31cm ≈ 25 Kg



**MESA CHAISE 26004**

CHAISE TABLE

74x17x31cm ≈ 20 Kg





# CONCRETE WOOD

CONCRETE WOOD

## VANTAGENS AMOP

- Alta Durabilidade
- Peso/Elevada Estabilidade
- Baixa Manutenção
- Neutro, fácil conjugação com mobiliário diverso

## AMOP BENEFITS

- High Durability
- Weight / High Stability
- Low Maintenance
- Neutral, easy to combine with other furniture pieces



## MESA CONCRETE WOOD

3000114011512

CONCRETE WOOD TABLE

Diam. 140x75cm 6 a 8 pessoas  
6 to 8 people

Tampo UHPC  
Table Top UHPC



Base Pinho Theermowood  
Base Thermowood Pine



# ROUND UP

ROUND UP

PRIVATE



## MESA ROUND UP

2800313011512

ROUND UP TABLE

Diam. 140x75cm 6 a 8 pessoas  
6 to 8 people



## MESA APOIO ROUND UP

2800513011512

ROUND UP SIDE TABLE

Diam. 80x45cm



## MESA BAR ROUND UP

2800113011612

ROUND UP BAR TABLE

Diam. 80x110cm

Tamos UHPC  
Table Tops UHPC



Base: Metal Lacado  
Base: Lacquered Metal



[www.amop.eu/private](http://www.amop.eu/private)



# HEXA, CRISTAL e SHAVINGS

HEXA, CRISTAL AND SHAVINGS

# ORGANII

*Bio Yourself.*



Revestimento de paredes em Betão UHPC com volumetria e escala que acrescentam valor estético e carácter às superfícies de espaços interiores.

*UHPC Concrete Wall Covering, with volumetry and scale, which add aesthetic value and character to the surfaces of indoor spaces.*

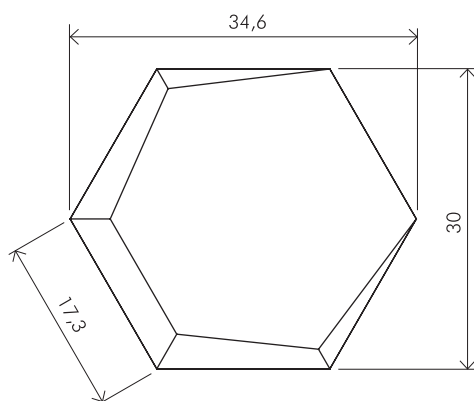

**HEXA BRANCO** 2700800011602  
HEXA WHITE  
34,6x30x2,3cm ≈ 2,7 Kg

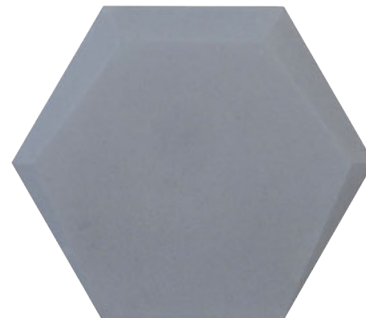

**HEXA CINZA** 2700800011502  
HEXA GREY  
34,6x30x2,3cm ≈ 2,7 Kg

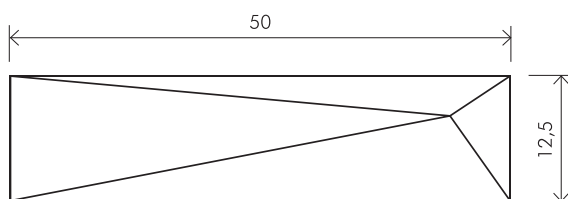

**CRISTAL BRANCO** 2700500011602  
CRISTAL WHITE  
50x12,5x2,3cm ≈ 2 Kg



**CRISTAL CINZA** 2700500011502  
CRISTAL GREY  
50x12,5x2,3cm ≈ 2 Kg



**SHAVINGS**  
SHAVINGS WHITE  
50x15x1,5cm ≈ 3 Kg Ref. 2700700011602  
100x15x1,5cm ≈ 6 Kg Ref. 2700600011602



**SHAVINGS**  
SHAVINGS GREY  
50x15x1,5cm ≈ 3 Kg Ref. 2700700011502  
100x15x1,5cm ≈ 6 Kg Ref. 2700600011502





AMOP, Lda  
R. Chão Redondo, 258  
Apt. 38  
3754-906 Aguada de Baixo  
Águeda - Portugal

T. 234 667 957  
F. 234 666 908  
E. amop@grupoamop.com

[www.grupoamop.com](http://www.grupoamop.com)

GPS  
N 40 30.837, W 8 26.465

Export Contacts  
T. +351 234 661 904  
F. +351 234 661 903  
E. export@grupoamop.com



SCAN QR CODE

